

**SMPS MOSFET**

**IRFP90N20D**

HEXFET® Power MOSFET

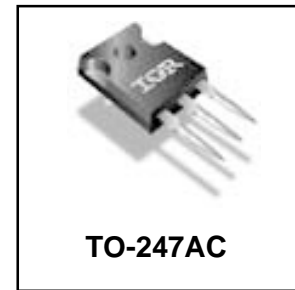
**Applications**

- High frequency DC-DC converters

<b>V<sub>DSS</sub></b>	<b>R<sub>DS(on) max</sub></b>	<b>I<sub>D</sub></b>
<b>200V</b>	<b>0.023Ω</b>	<b>94A<sup>Ⓔ</sup></b>

**Benefits**

- Low Gate-to-Drain Charge to Reduce Switching Losses
- Fully Characterized Capacitance Including Effective C<sub>OSS</sub> to Simplify Design, (See App. Note AN1001)
- Fully Characterized Avalanche Voltage and Current



**Absolute Maximum Ratings**

	<b>Parameter</b>	<b>Max.</b>	<b>Units</b>
I <sub>D</sub> @ T <sub>C</sub> = 25°C	Continuous Drain Current, V <sub>GS</sub> @ 10V	94 <sup>Ⓔ</sup>	A
I <sub>D</sub> @ T <sub>C</sub> = 100°C	Continuous Drain Current, V <sub>GS</sub> @ 10V	66	
I <sub>DM</sub>	Pulsed Drain Current <sup>Ⓓ</sup>	380	
P <sub>D</sub> @ T <sub>C</sub> = 25°C	Power Dissipation	580	W
	Linear Derating Factor	3.8	W/°C
V <sub>GS</sub>	Gate-to-Source Voltage	± 30	V
	Peak Diode Recovery dv/dt <sup>Ⓢ</sup>	6.7	V/ns
T <sub>J</sub>	Operating Junction and Storage Temperature Range	-55 to + 175	°C
T <sub>STG</sub>			
	Mounting torque, 6-32 or M3 screw	10 lbf•in (1.1N•m)	

**Thermal Resistance**

	<b>Parameter</b>	<b>Typ.</b>	<b>Max.</b>	<b>Units</b>
R <sub>θJC</sub>	Junction-to-Case	—	0.26	°C/W
R <sub>θCS</sub>	Case-to-Sink, Flat, Greased Surface	0.24	—	
R <sub>θJA</sub>	Junction-to-Ambient	—	40	

Notes <sup>Ⓓ</sup> through <sup>Ⓔ</sup> are on page 8

## Static @ $T_J = 25^\circ\text{C}$ (unless otherwise specified)

	Parameter	Min.	Typ.	Max.	Units	Conditions
$V_{(BR)DSS}$	Drain-to-Source Breakdown Voltage	200	—	—	V	$V_{GS} = 0V, I_D = 250\mu A$
$\Delta V_{(BR)DSS}/\Delta T_J$	Breakdown Voltage Temp. Coefficient	—	0.24	—	V/°C	Reference to $25^\circ\text{C}, I_D = 1\text{mA}$
$R_{DS(on)}$	Static Drain-to-Source On-Resistance	—	—	0.023	$\Omega$	$V_{GS} = 10V, I_D = 56A$ ④
$V_{GS(th)}$	Gate Threshold Voltage	3.0	—	5.0	V	$V_{DS} = V_{GS}, I_D = 250\mu A$
$I_{DSS}$	Drain-to-Source Leakage Current	—	—	25	$\mu A$	$V_{DS} = 200V, V_{GS} = 0V$
		—	—	250		$V_{DS} = 160V, V_{GS} = 0V, T_J = 150^\circ\text{C}$
$I_{GSS}$	Gate-to-Source Forward Leakage	—	—	100	nA	$V_{GS} = 30V$
	Gate-to-Source Reverse Leakage	—	—	-100		$V_{GS} = -30V$

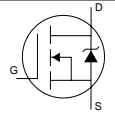
## Dynamic @ $T_J = 25^\circ\text{C}$ (unless otherwise specified)

	Parameter	Min.	Typ.	Max.	Units	Conditions	
$g_{fs}$	Forward Transconductance	39	—	—	S	$V_{DS} = 50V, I_D = 56A$	
$Q_g$	Total Gate Charge	—	180	270	nC	$I_D = 56A$ $V_{DS} = 160V$ $V_{GS} = 10V, \text{④}$	
$Q_{gs}$	Gate-to-Source Charge	—	45	67			
$Q_{gd}$	Gate-to-Drain ("Miller") Charge	—	87	130			
$t_{d(on)}$	Turn-On Delay Time	—	23	—	ns	$V_{DD} = 100V$ $I_D = 56A$ $R_G = 1.2\Omega$ $V_{GS} = 10V$ ④	
$t_r$	Rise Time	—	160	—			
$t_{d(off)}$	Turn-Off Delay Time	—	43	—			
$t_f$	Fall Time	—	79	—			
$C_{iss}$	Input Capacitance	—	6040	—	pF	$V_{GS} = 0V$ $V_{DS} = 25V$ $f = 1.0\text{MHz}$	
$C_{oss}$	Output Capacitance	—	1070	—			
$C_{rss}$	Reverse Transfer Capacitance	—	170	—			
$C_{oss}$	Output Capacitance	—	8350	—			$V_{GS} = 0V, V_{DS} = 1.0V, f = 1.0\text{MHz}$
$C_{oss}$	Output Capacitance	—	420	—			$V_{GS} = 0V, V_{DS} = 160V, f = 1.0\text{MHz}$
$C_{oss \text{ eff.}}$	Effective Output Capacitance	—	870	—			$V_{GS} = 0V, V_{DS} = 0V \text{ to } 160V$ ⑤

## Avalanche Characteristics

	Parameter	Typ.	Max.	Units
$E_{AS}$	Single Pulse Avalanche Energy②	—	1010	mJ
$I_{AR}$	Avalanche Current①	—	56	A
$E_{AR}$	Repetitive Avalanche Energy①	—	58	mJ

## Diode Characteristics

	Parameter	Min.	Typ.	Max.	Units	Conditions
$I_S$	Continuous Source Current (Body Diode)	—	—	94⑥	A	MOSFET symbol showing the integral reverse p-n junction diode. 
$I_{SM}$	Pulsed Source Current (Body Diode) ①	—	—	380		
$V_{SD}$	Diode Forward Voltage	—	—	1.5	V	$T_J = 25^\circ\text{C}, I_S = 56A, V_{GS} = 0V$ ④
$t_{rr}$	Reverse Recovery Time	—	230	340	ns	$T_J = 25^\circ\text{C}, I_F = 56A$
$Q_{rr}$	Reverse Recovery Charge	—	1.9	2.8	$\mu C$	$di/dt = 100A/\mu s$ ④
$t_{on}$	Forward Turn-On Time	Intrinsic turn-on time is negligible (turn-on is dominated by $L_S + L_D$ )				

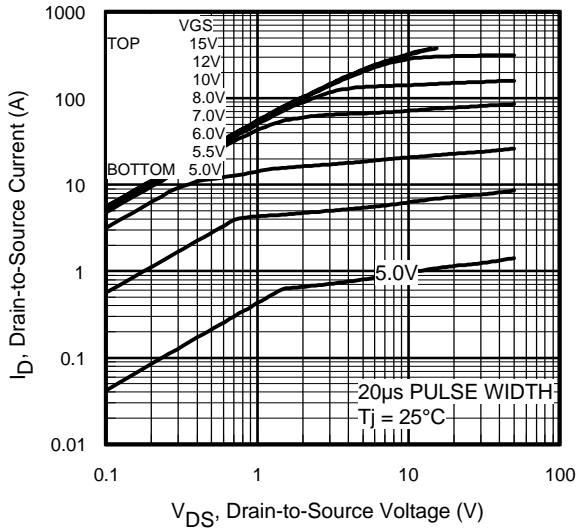


Fig 1. Typical Output Characteristics

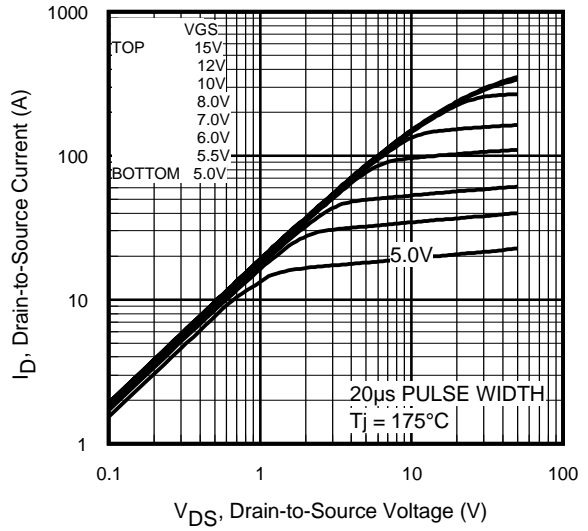


Fig 2. Typical Output Characteristics

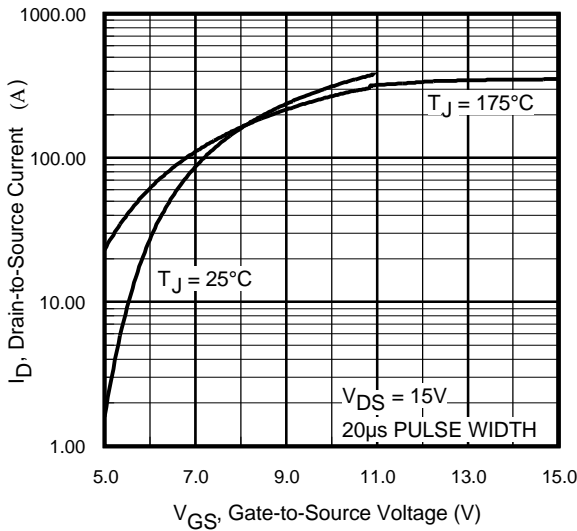


Fig 3. Typical Transfer Characteristics

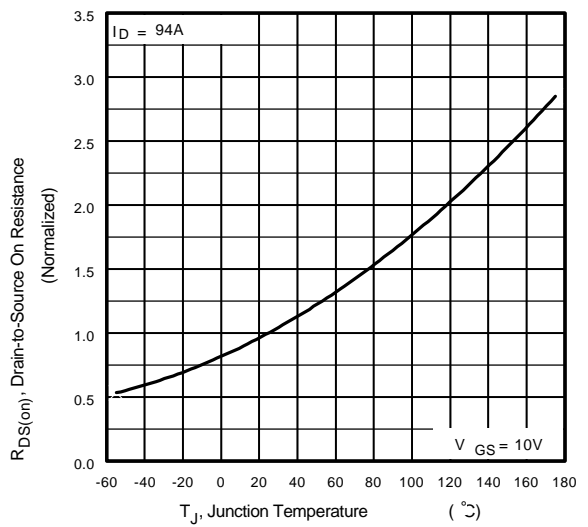
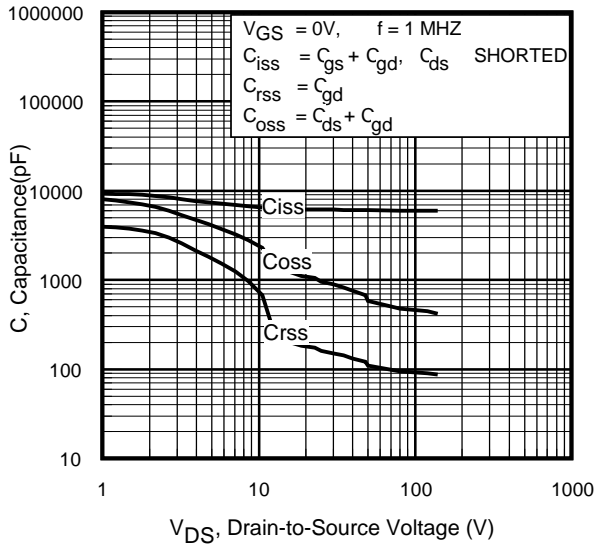
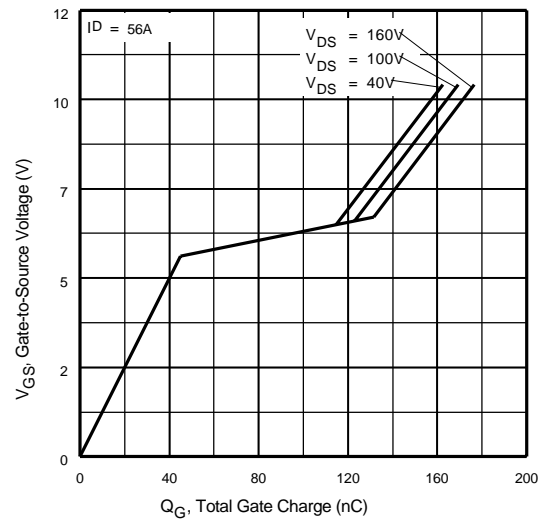


Fig 4. Normalized On-Resistance vs. Temperature

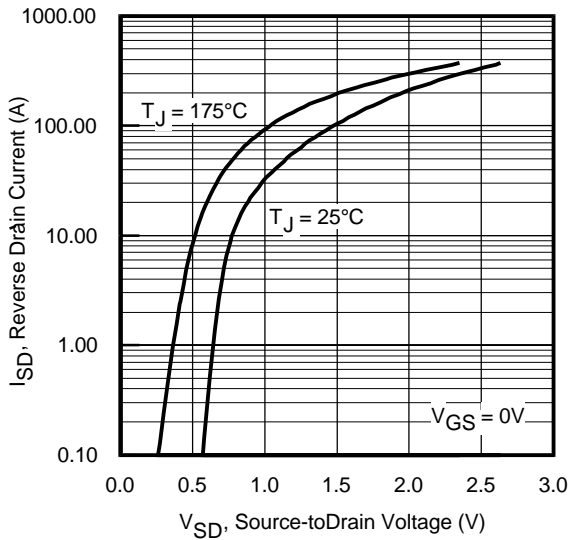
# IRFP90N20D



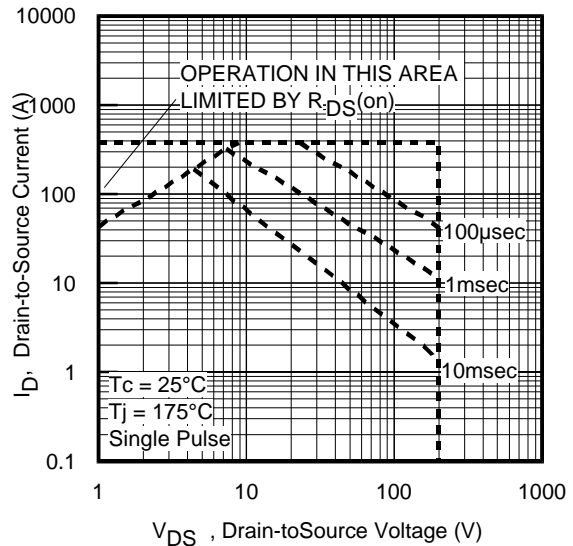
**Fig 5.** Typical Capacitance vs. Drain-to-Source Voltage



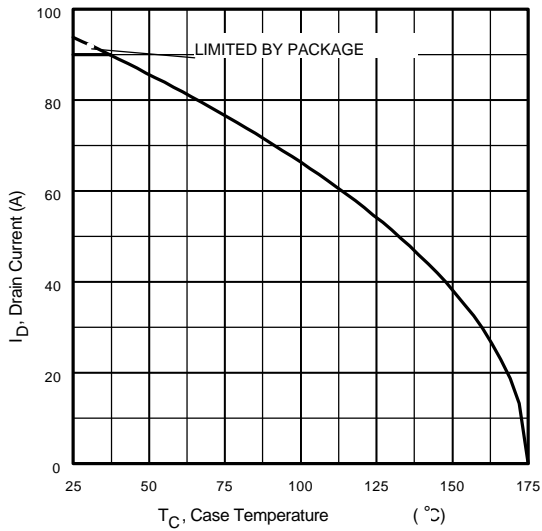
**Fig 6.** Typical Gate Charge vs. Gate-to-Source Voltage



**Fig 7.** Typical Source-Drain Diode Forward Voltage



**Fig 8.** Maximum Safe Operating Area



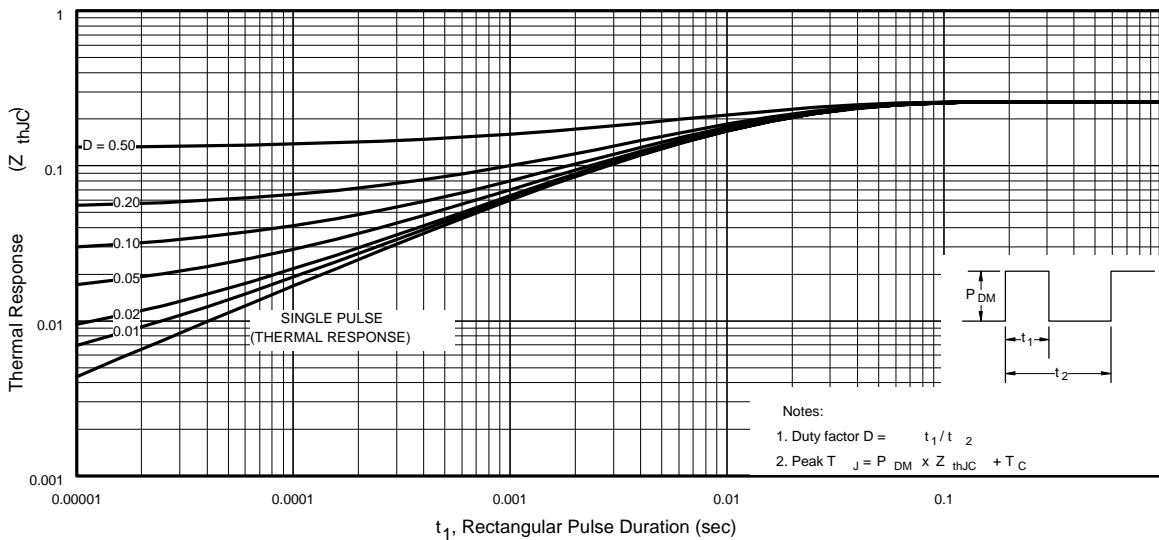
**Fig 9.** Maximum Drain Current vs. Case Temperature



**Fig 10a.** Switching Time Test Circuit



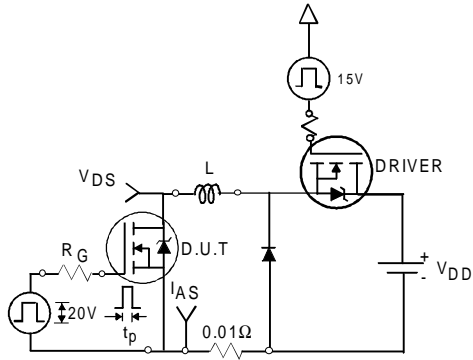
**Fig 10b.** Switching Time Waveforms



**Fig 11.** Maximum Effective Transient Thermal Impedance, Junction-to-Case

# IRFP90N20D

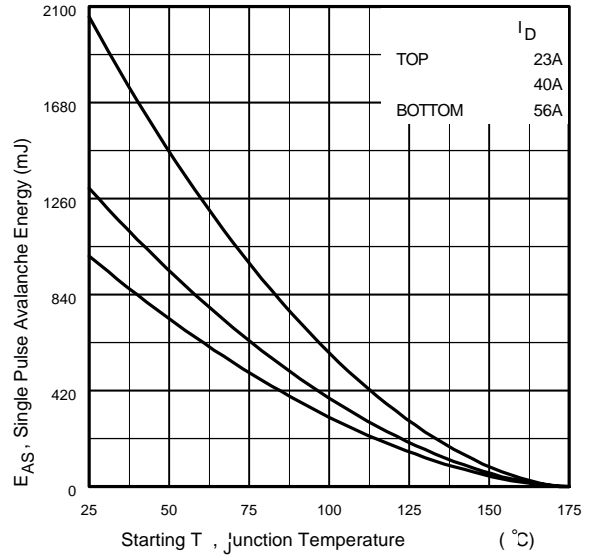
International  
**IR** Rectifier



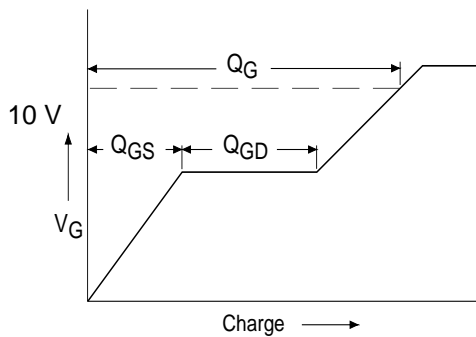
**Fig 12a.** Unclamped Inductive Test Circuit



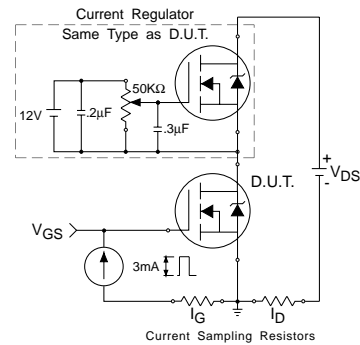
**Fig 12b.** Unclamped Inductive Waveforms



**Fig 12c.** Maximum Avalanche Energy vs. Drain Current

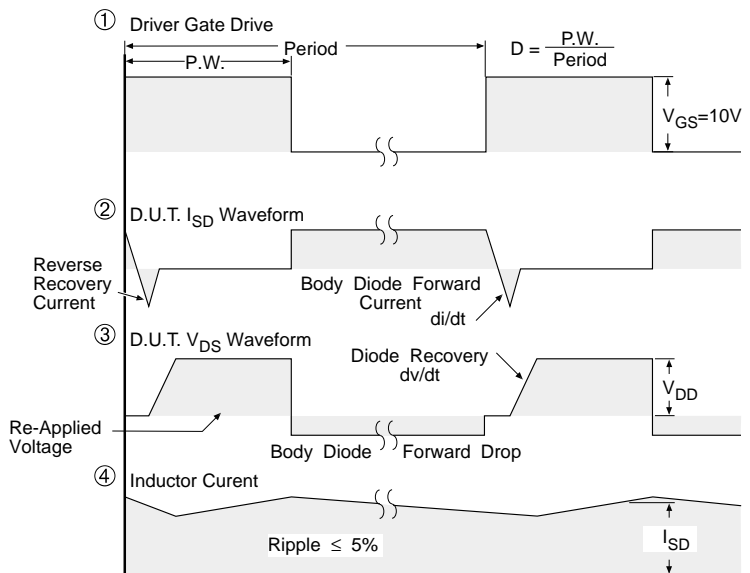
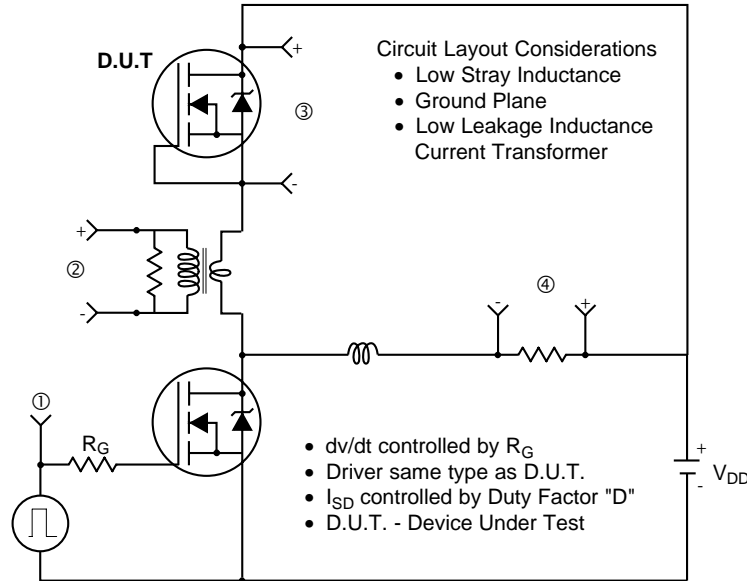


**Fig 13a.** Basic Gate Charge Waveform



**Fig 13b.** Gate Charge Test Circuit

**Peak Diode Recovery dv/dt Test Circuit**



\*  $V_{GS} = 5V$  for Logic Level Devices

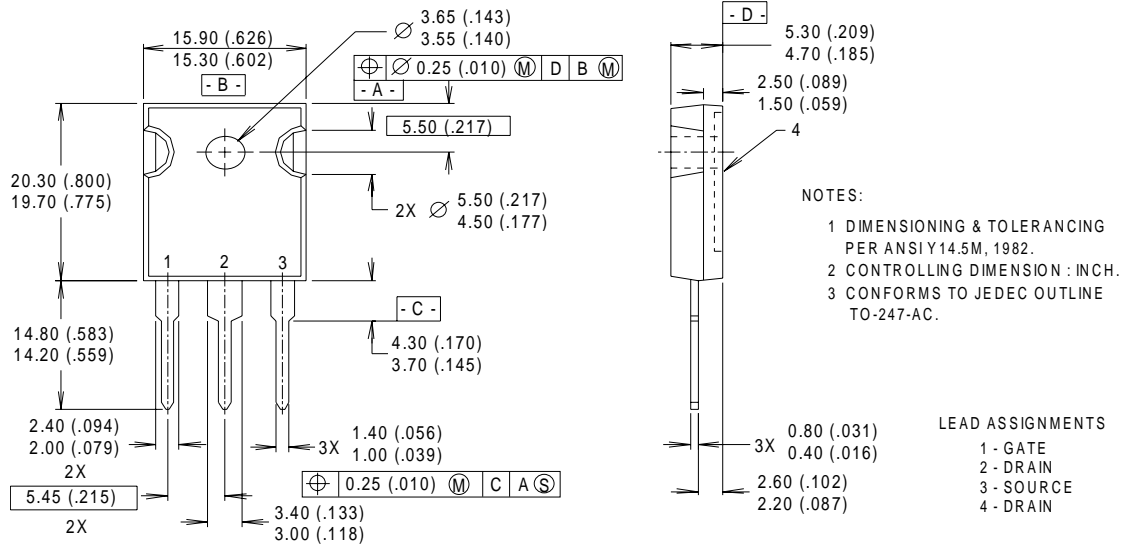
**Fig 14.** For N-Channel HEXFET® Power MOSFETs

# IRFP90N20D

International  
**IR** Rectifier

## TO - 247 Package Outline

Dimensions are shown in millimeters (inches)



### Notes:

- ① Repetitive rating; pulse width limited by max. junction temperature.
- ② Starting  $T_J = 25^\circ\text{C}$ ,  $L = 0.64\text{mH}$   
 $R_G = 25\Omega$ ,  $I_{AS} = 56\text{A}$ .
- ③  $I_{SD} \leq 56\text{A}$ ,  $di/dt \leq 470\text{A}/\mu\text{s}$ ,  $V_{DD} \leq V_{(BR)DSS}$ ,  
 $T_J \leq 175^\circ\text{C}$
- ④ Pulse width  $\leq 300\mu\text{s}$ ; duty cycle  $\leq 2\%$ .
- ⑤  $C_{OSS}$  eff. is a fixed capacitance that gives the same charging time as  $C_{OSS}$  while  $V_{DS}$  is rising from 0 to 80%  $V_{DSS}$
- ⑥ Calculated continuous current based on maximum allowable junction temperature. Package limitation current is 90A.

Data and specifications subject to change without notice.  
This product has been designed and qualified for the Industrial market.  
Qualification Standards can be found on IR's Web site.

International  
**IR** Rectifier

**IR WORLD HEADQUARTERS:** 233 Kansas St., El Segundo, California 90245, USA Tel: (310) 252-7105  
TAC Fax: (310) 252-7903

Visit us at [www.irf.com](http://www.irf.com) for sales contact information.09/01

[www.irf.com](http://www.irf.com)



Note: For the most current drawings please refer to the IR website at:  
<http://www.irf.com/package/>